

SPECIFICATION

LED Light Stromboli IP65 EX



SPECIFICATION

LED Light Stromboli IP65 EX

Caution

- Please read the user manual before installation.
- Please install, connect and test the lamp according to local regulations, Lamps should always be installed or replaced with care by professional person.
- Ensure the power is switched off before installation.
- Please check whether the lamps are broken or not during shipping, broken items cannot be used anymore.
- Please keep the lamps and accessories away from kids to avoid hurt by mistakes.
- For protecting eyes, please do not watch the luminous surface for a long time,
- Do not cover anything on lamp and keep lamps away from fire or high temperature objects.
- Incorrect installation and using, Barlux keep the right to refuse after-sales service for those disassembled or repaired items.
- Switch the power off and cool down the lamp before cleaning.
- The lamp is only suitable for weak acid and weak base environment.
- Please DO NOT install this product in the following places:
 1. The place has a large quantity of lampblack and smoke, such as: kitchen and food processing factory etc.
 2. The place has a large quantity of chemical corrosive substance, such as: chemical plant and stockyard etc.
 3. The place has poor temperature conditions, large-scale temperature variation, which would easily lead to broken and damage the product, the applicable operating temperature is between -20 and 50 degrees.

S/N Rules

BS-X1X2 - X3W - X4 (X5)
Example : BS-M120-40W-P(D)

- BS – Barlux Stromboli
- X1 – Cover type (S-strip, M-milky)
- X2 – Length (60, 120, 150 cm)
- X3 – Power consumption (20, 30, 40, 50, 60 W)
- X4 – Color temperature (W- 3500 K, P-5000 K, C-6500 K)
- X5 – Function type (E-emergency, S-sensor, D-dimmable)

Features

- Unique patent design, TUV-GS, UL, DLC, ERP, CE certified.
- Water-proof, Dust-proof, Damp-proof, Pressure-proof.
- High luminous efficiency 100 - 115LM/W.
- Maximum 3M Long for single product.
- Excellent heat dissipation support stable quality.
- Convention installation for linking in series.
- Low light decay, L70=50,000 Hours.
- High impact test, IK09.
- Long lifespan 50,000 hours.
- Energy saving up to 80%.
- 5 years warranty.

Application

- Parking place
- Tunnel / Corridor / Gallery
- Railway / Bus / MTR Station
- Warehouse / Factory
- Airport
- Exhibition Hall
- Supermarket
- Gas station

Dimension

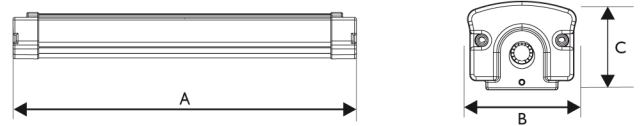

length	A	B	C
	Min.mm	Min.mm	Max.mm
600	600	91	92
1200	1200	91	92
1500	1500	91	92

Temperature Characteristics T-ambient 40°C

Temperature
 Operating: -20 ~ +50°C
 Storage: -40 ~ +85°C



Data Sheet

Item code	Input Voltage	Power	LEDs	Working	PF	Luminous Flux	Luminous Efficiency	CRI	THD	Power Efficiency
BS-M60-20W-X-X	100-240V/277V	20W	120	DC34-40V	>0.95	1900-2100LM	90-100LM/W	>80	<15%	>0.88
BS-S60-20W-X-X	100-240V/277V	20W	120	DC34-40V	>0.95	2100-2400LM	100-115LM/W	>80	<15%	>0.88
BS-M60-25W-X-X	100-240V/277V	25W	144	DC34-40V	>0.95	2300-2600LM	90-100LM/W	>80	<15%	>0.88
BS-S60-25W-X-X	100-240V/277V	25W	144	DC34-40V	>0.95	2600-2900LM	100-115LM/W	>80	<15%	>0.88
BS-M60-30W-X-X	100-240V/277V	30W	180	DC34-40V	>0.95	2800-3100LM	90-100LM/W	>80	<15%	>0.88
BS-S60-30W-X-X	100-240V/277V	30W	180	DC34-40V	>0.95	3200-3500LM	100-115LM/W	>80	<15%	>0.88
BS-M120-40W-X-X	100-240V/277V	40W	240	DC34-40V	>0.95	3600-4000LM	90-100LM/W	>80	<15%	>0.88
BS-S120-40W-X-X	100-240V/277V	40W	240	DC34-40V	>0.95	4000-4400LM	100-110LM/W	>80	<15%	>0.88
BS-M120-50W-X-X	100-240V/277V	50W	288	DC34-40V	>0.95	4500-5000LM	90-100LM/W	>80	<15%	>0.88
BS-S120-50W-X-X	100-240V/277V	50W	288	DC34-40V	>0.95	5000-5500LM	100-110LM/W	>80	<15%	>0.88
BS-M150-50W-X-X	100-240V/277V	50W	288	DC34-40V	>0.95	4500-5000LM	90-100LM/W	>80	<15%	>0.88
BS-S150-50W-X-X	100-240V/277V	50W	288	DC34-40V	>0.95	5000-5500LM	100-110LM/W	>80	<15%	>0.88
BS-M150-60W-X-X	100-240V/277V	60W	336	DC34-40V	>0.95	5400-5900LM	90-100LM/W	>80	<15%	>0.88
BS-S150-60W-X-X	100-240V/277V	60W	336	DC34-40V	>0.95	5900-6400LM	100-110LM/W	>80	<15%	>0.88

Optical Parameter

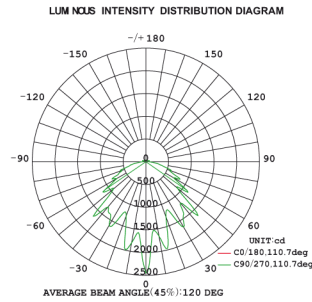
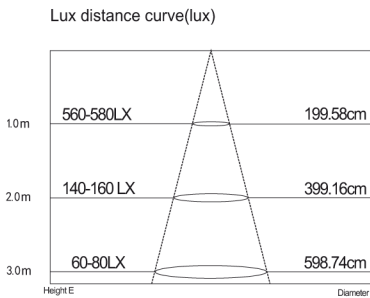

Item code	1m	2m	3m
BS-M60-20W-X-X	560-580	140-160	60-80
BS-S60-20W-X-X	740-760	180-200	80-100
BS-M60-25W-X-X	720-740	180-200	80-100
BS-S60-25W-X-X	870-880	220-240	100-120
BS-M60-30W-X-X	860-880	215-235	85-115
BS-S60-30W-X-X	1150-1170	290-310	130-150
BS-M120-40W-X-X	1150-1170	290-310	130-150
BS-S120-40W-X-X	1600-1620	390-410	180-200
BS-M120-50W-X-X	1440-1460	360-380	160-180
BS-S120-50W-X-X	1800-1820	450-470	200-220
BS-M150-50W-X-X	1470-1480	370-380	165-185
BS-S150-50W-X-X	1920-1940	480-500	220-240
BS-M150-60W-X-X	1700-1720	425-445	190-210
BS-S150-60W-X-X	2120-2130	530-550	240-260

Item code	Beam Angle
BS-M60-20W-X-X	120
BS-S60-20W-X-X	120
BS-M60-25W-X-X	120
BS-S60-25W-X-X	120
BS-M60-30W-X-X	120
BS-S60-30W-X-X	120
BS-M120-40W-X-X	120
BS-S120-40W-X-X	120
BS-M120-50W-X-X	120
BS-S120-50W-X-X	120
BS-M150-50W-X-X	120
BS-S150-50W-X-X	120
BS-M150-60W-X-X	120
BS-S150-60W-X-X	120

Ceiling Mounted Installation

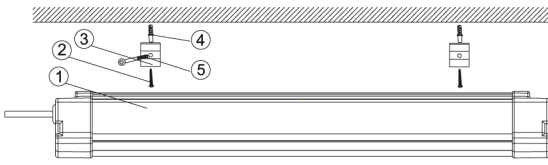

① Drill $\Phi 6\text{mm}$ holes on the roof/wall.



③ Ceiling Installation

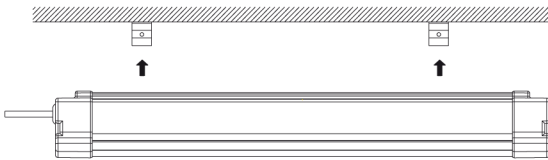

Standard parts list

1	LED Light Stromboli IP65 EX	1PC
2	U-shape Brackets	2PCS
3	Self-tapping screws	2PCS
4	Slotted plastic screws	2PCS
5	PM4X40 screws	2PCS

* Ceiling Mounted accessories are Barlux Configuration.

② Insert $\Phi 6\text{mm}$ expansion pipe into the hole and fix the bracket by M4 screw.

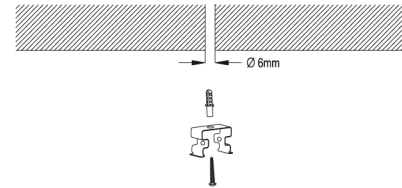

Tighten the screw with screwdriver

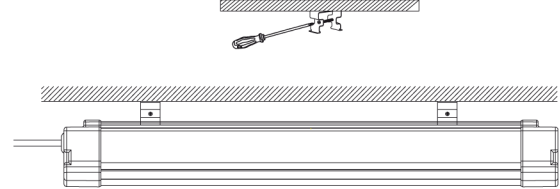

Suspended Installation

① Suspended way.

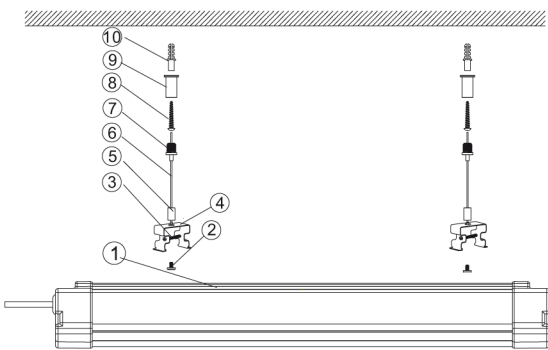

② Hanging Installation.

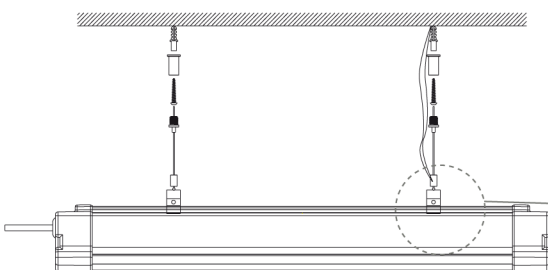

Spare Parts

1	LED Light Stromboli IP65 EX	1PC
2	Ring washer	2PCS
3	Suspension fixing screws	2PCS
4	U-shape brackets	2PCS
5	Suspension fixing nuts	2PCS
6	Suspension wires	2PCS
7	Suspension fixing bushings	2PCS
8	Self-tapping screws	2PCS
9	light fixing bushing cap	2PCS
10	Slotted plastic screws	2PCS

* Suspended accessories need to be paid additionally.

Tighten the screw with screwdriver.

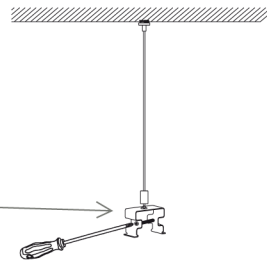

Conventional UL/VDE standard wire for 18 AWG / $3 \times 0.75\text{MM}^2$

Series Connection

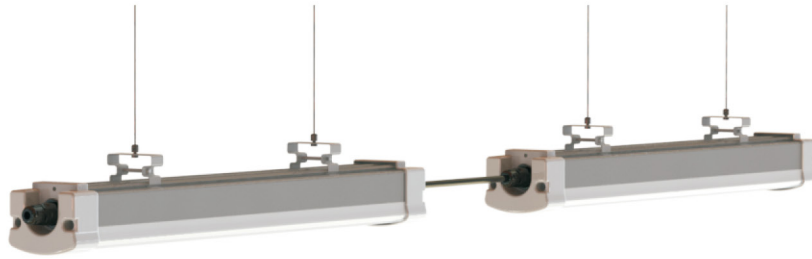

Available to be connected in series by fast connectors.

Optional Connector A:



1: Insert the wire into the terminal then use screw locking it.

2: Put the protector on the terminal.

3: Put on waterproof set.

4: Lock the waterproof sets tightly.

PLS NOTE: Above connectors and wire are separated, easy for connecting the lamps by customized length of wire, NEED to be paid additionally.

Optional Connector B:

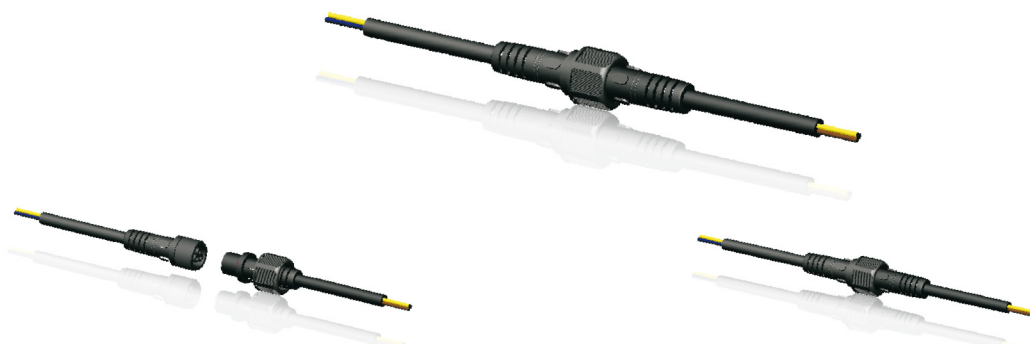

1. Joint Female and Male connector together.

2. Lock the waterproof cap tightly.

PLS NOTE: Above connectors and wire are fixed, need to confirm the detailed length correctly, and pay it additionally.

Seamless Connection

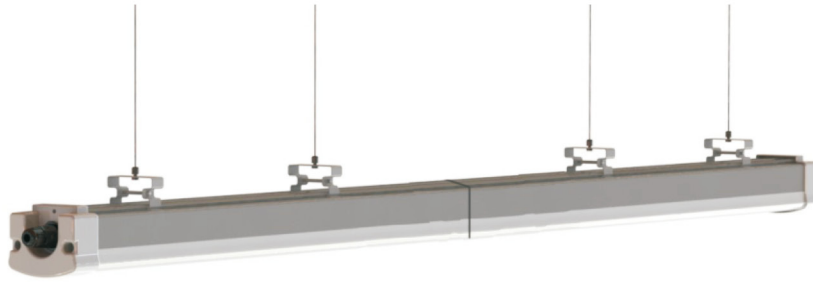

Available to be connected in series by smart aluminum strip.

Seamless Connection Installation

- ① Hanging up the light (without end cap) with suspended accessories.

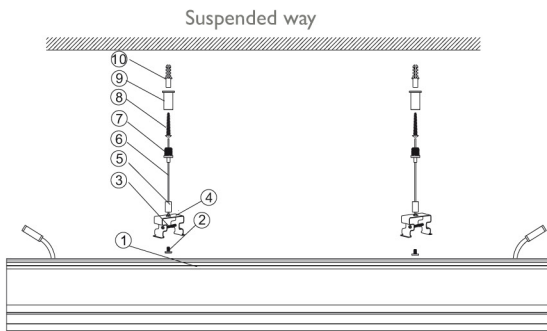

Spare Parts

1	LED Light Stromboli IP65 EX	1PC
2	Ring washer	2PCS
3	Suspension fixing screws	2PCS
4	U-shape brackets	2PCS
5	Suspension fixing nuts	2PCS
6	Suspension wires	2PCS
7	Suspension fixing bushings	2PCS
8	Self-tapping screws	2PCS
9	light fixing bushing cap	2PCS
10	Slotted plastic screws	2PCS

* Suspended accessories need to be paid additionally.

- ② Insert the smart aluminum strip into the light aluminum housing till the ball buckle is locked.

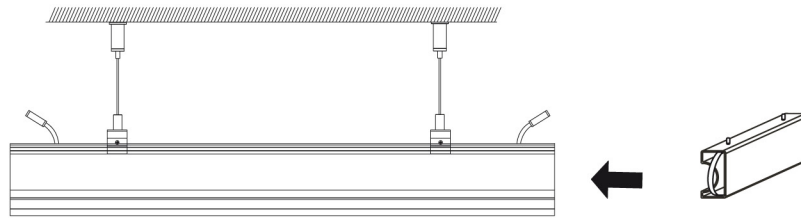

- ③ Fix another light (without end cap) onto the other end of smart aluminum strip till the ball buckle is locked.

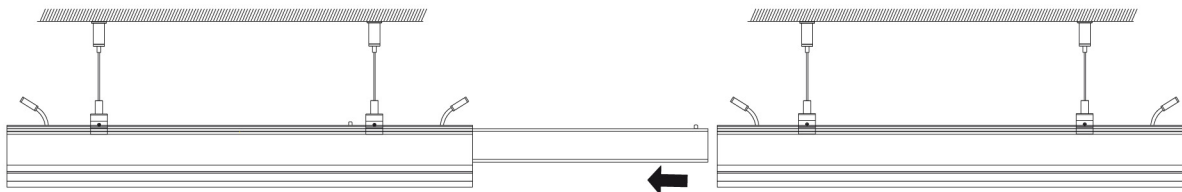

- ④ Connect the wires correctly.

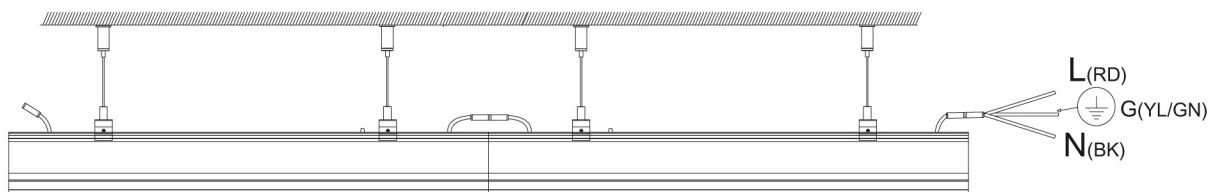

PLS NOTE: The Stromboli IP65 EX is NOT water-proof under Seamless Connection Installation.

The maximum number of lamps for Linking in series

Item code	Size	Power	voltage	Max. Series Connection Q'TY	voltage	Max. Series Connection Q'TY
BS-X60-20W-X-X	600*91*74	20W	110V	27pcs	220V	54pcs
BS- X60- 20W-X-X	600*91*74	20W	110V	22pcs	220V	48pcs
BS-X60-30W-X-X	600*91*74	30W	110V	18pcs	220V	36pcs
BS-X120-40W- X-X	1200*91*74	40W	110V	13pcs	220V	27pcs
BS-X120-50W-X-X	1200*91*74	50W	110V	10pcs	220V	21pcs
BS-X150-50W-X-X	1500*91*74	50W	110V	10pcs	220V	21pcs
BS-X150-60W-X-X	1500*91*74	60W	110V	9pcs	220V	18pcs

Wiring Diagram

Non Dimmable LED Light Stroboli IP65 EX



(EU market-3 pole cable) (US market-3 pole cable)

L:	Brown	Black
N:	Blue	White
E:	Yellow-Green	Green

TRIAC Dimmable LED Light Stroboli IP65 EX



(EU market-3 pole cable) (US market-3 pole cable)

L:	Brown	Black
N:	Blue	White
E:	Yellow-Green	Green

0/1-10V Dimmable LED Light Stroboli IP65 EX



(EU market-5 pole cable) (US market-5 pole cable)

L:	Brown	Black
N:	Blue	White
E:	Yellow	Green
DIM+:	Red	Red
DIM-:	Green	Orange

DALI Dimmable LED Light Stroboli IP65 EX



(EU market-5 pole cable) (US market-5 pole cable)

L:	Brown	Black
N:	Blue	White
E:	Yellow	Green
DA:	Red	Red
DA:	Green	Orange

Available Dimming way

Suggested suitable dimmer brands for TRIAC & DALI dimming way:

Tridonic (European market)

Lutron & Leviton (American market)

Philips Dynalite & Clipsal (Australian market)

Package

LED Light Stroboli IP65 EX

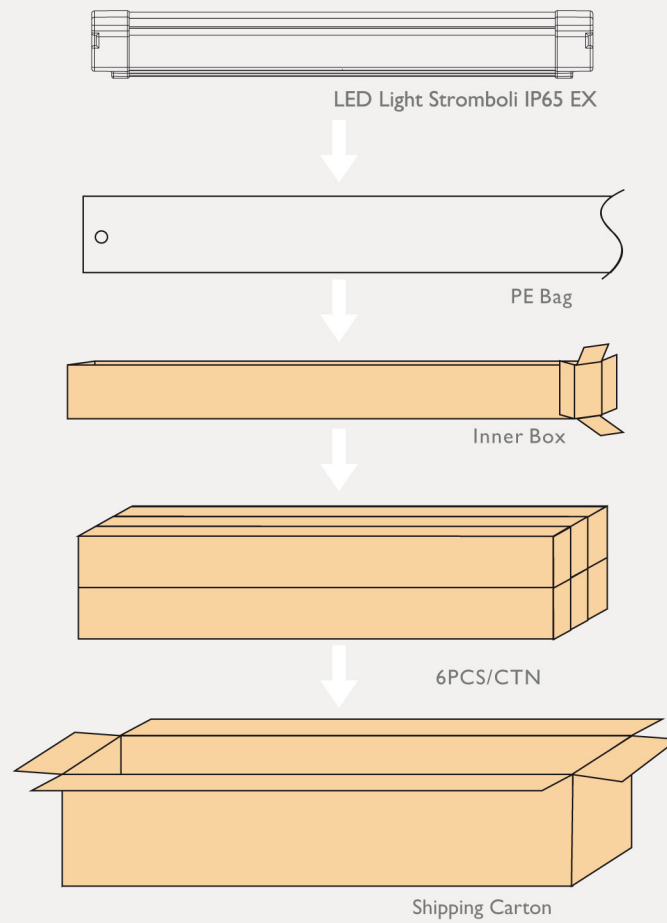

Item code	Dimension	Carton Size	N.W. (kg) /PC	G. W. (kg) /CTN
BS-X60-20W-X-X	600*91*74mm	680*260*300mm	1.2	9.2
BS- X60- 20W-X-X	600*91*74mm	680*260*300mm	1.2	9.2
BS-X60-30W-X-X	600*91*74mm	680*260*300mm	1.2	9.2
BS-X120-40W- X-X	1200*91*74mm	1280*260*300mm	2	16
BS-X120-50W-X-X	1200*91*74mm	1280*260*300mm	2	16
BS-X150-50W-X-X	1500*91*74mm	1580*260*300mm	2.6	20
BS-X150-60W-X-X	1500*91*74mm	1580*260*300mm	2.6	20

ATTENTION:

Barlux reserves the right of final interpretation for all specifications.